

Arduino Interface

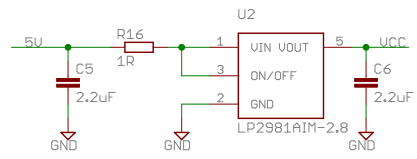

5V to 3.3V Conversion

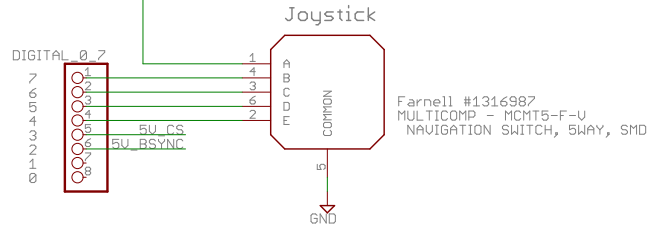
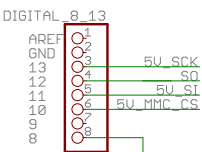
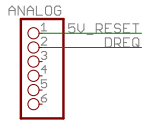
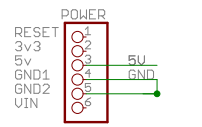
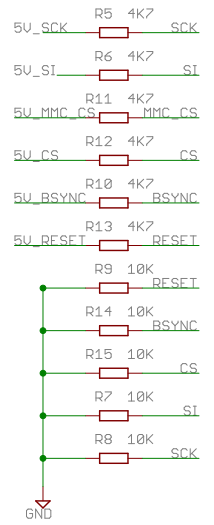

DREQ and S0 are not converted as they are outputs to the Arduino

MP3 to Audio decoding

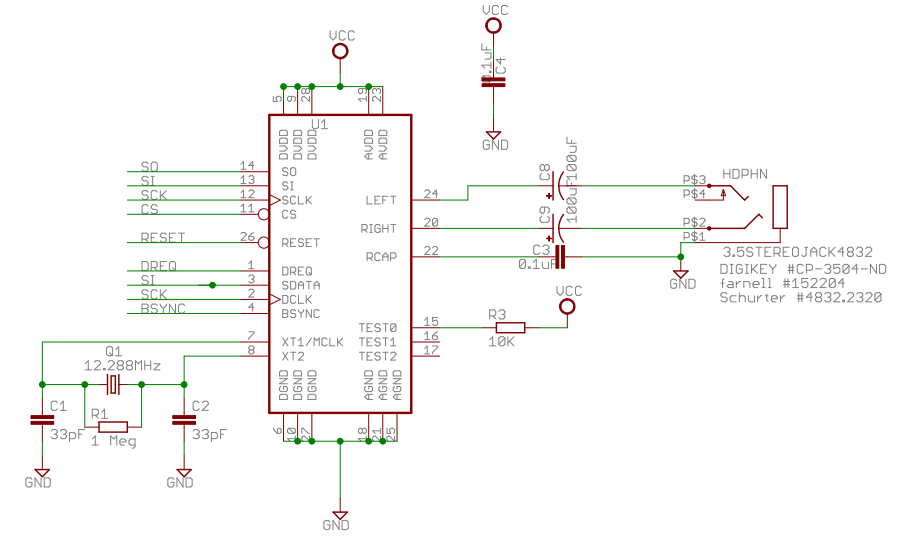

MMC / SD Card Interface

